

Serving the Water & Waste Water Industry Since 1878

ECCENTRIC PLUG VALVES



C517 • 3"–24" sizes available • Multiple end connections available



M&H VALVE COMPANY

M&H Valve is a division of McWane, Inc.

www.mh-valve.com



For Generations

AVAILABLE END CONNECTIONS



M&H VALVE COMPANY

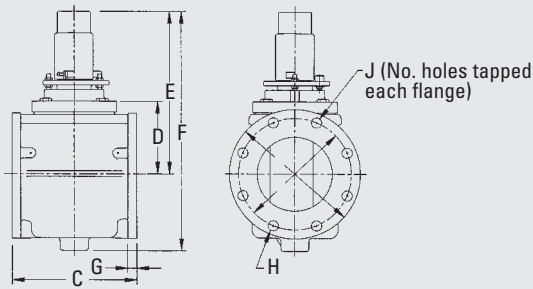

1820-02 FLANGE END

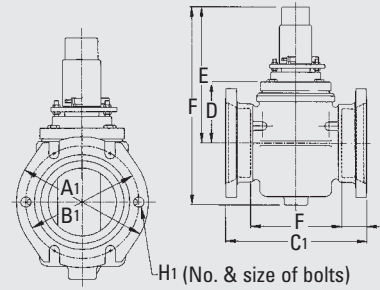

1820-01 MECHANICAL JOINT END

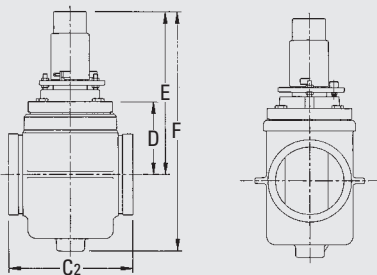

1820-GR GROOVED END

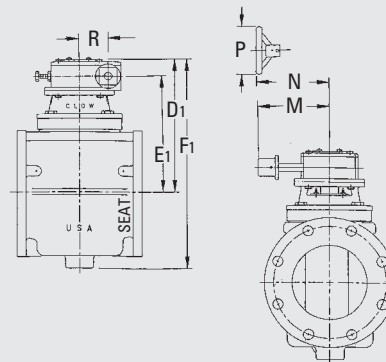

ALL ENDS WITH WORM GEAR

VALVE SIZE	A	A1	B	B1	C	C1	C2	D	D1	E	E1	F
3	7 1/2	7 5/8	6	6 3/16	8	11 7/8	9	3 15/32	*	6 3/4	*	11
4	9	9 1/8	7 1/2	7 1/2	9	12 1/4	9	4 7/16	9 3/16	11	11 1/16	16 3/8
6	11	11 1/8	9 1/2	9 1/2	10 1/2	14 1/8	10 1/2	6 1/8	10 7/8	14 1/2	12 3/4	21
8	13 1/2	13 3/4	11 3/4	11 3/4	11 1/2	17 1/2	15 1/2	7 5/8	12 3/8	16	14 1/4	24 1/4
10	16	15 3/4	14 1/4	14	13	19 3/8	17 1/4	9 3/4	14 1/2	15	16 3/8	25 3/16
12	19	18	17	16 1/4	14	20 3/4	18	11 5/16	16 1/16	16 1/2	17 15/16	29 1/4
14	21	20 5/16	18 3/4	18 7/8	17	24 1/2	21 5/8	12 7/8	*	20 1/4	*	34 1/2
16	23 1/2	22 1/2	21 1/4	21	17 3/4	24 3/4	22 1/2	14	*	21 1/2	*	37 1/4
18	25	24 3/4	22 3/4	23 1/4	21 1/2	28 5/8	*	16 1/8	*	23 1/2	*	40 5/8
20	27 1/2	27	25	25 1/2	23 1/2	30 3/4	*	17 3/4	*	25 1/8	*	45 1/8
24	32	31 1/2	29 1/2	30	30	37	*	19 1/8	*	26	*	53

VALVE SIZE	F1	G	H	H1	J	K	L	M	N	P	R
3	*	3/4	4- 5/8	4- 5/8	0	6 7/8	2 1/2	*	*	*	*
4	16 7/16	1	8- 5/8	4- 3/4	4	7 1/4	2 1/2	8	11	10	3 1/4
6	19 1/4	1 1/16	8- 3/4	6- 3/4	2	9 1/8	2 1/2	8	11	10	3 1/4
8	22 1/2	1 3/16	8- 3/4	6- 3/4	4	12 1/2	2 1/2	8	11	10	3 1/4
10	26 11/16	1 1/4	12- 7/8	8- 3/4	4	14 3/8	2 1/2	8	11-12	10-18	3 1/4
12	30	1 1/4	12- 7/8	8- 3/4	4	15 3/4	2 1/2	8	11-12	10-18	3 1/4
14	*	1 3/8	12-1	10-3/4	4	17 1/2	3 1/2	*	*	*	*
16	*	1 7/16	16-1	12-3/4	6	17 3/4	3 1/2	*	*	*	*
18	*	1 9/16	16-1 1/8	12-3/4	8	21 5/8	3 1/2	*	*	*	*
20	*	1 11/16	20-1 1/8	14-3/4	8	23 3/4	3 1/2	*	*	*	*
24	*	1 7/8	20-1 1/4	16-3/4	8	30	3 1/2	*	*	*	*

ECCENTRIC PLUG VALVES



FROM M&H VALVE CO.

Eccentric Plug Valves from M&H are designed for consistent performance, durability and longevity. Built to exacting standards, M&H Eccentric Plug Valves are available in sizes from 3"– 24" and with a variety of end connections. Regardless of your project's needs, a M&H Eccentric Plug Valve is certain to be a perfect fit and a wise choice.

CLOSED

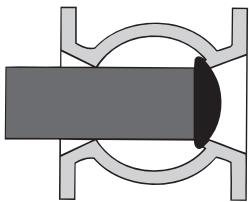

As the plug component is rotated to valve closure, the offset condition of the plug causes the seating surface to move axially downstream into the nickel seat. This results in a high-seating force thereby crushing trapped solids and resulting in a bubble-tight seal. The upstream pressure acting on the convex side of the plug further improves the bubble-tight seal.

OPENING

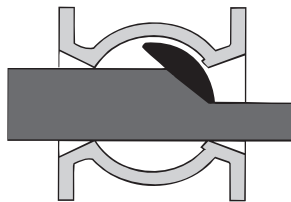

Upon opening the valve, the initial rotation of the plug causes the resilient seating surface to move axially away from the nickel seat in the body. This action minimizes wear and scraping of the resilient seat, thereby improving the life of the valve. The plug can be positioned at any position between open and closed for throttling applications.

OPEN

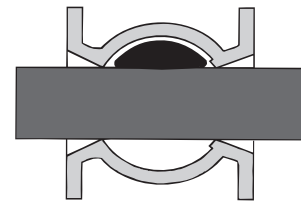

In the full open position, the plug is rotated out of the main fluid stream as shown. This allows for high-capacity flow through the valve.

ENGINEERING FEATURES

POSITION INDICATOR AND MEMORY STOP

M&H quarter-turn valves are equipped with a position indicator marked at 10 degree increments and an open position memory stop that can be used for balancing applications.

O-RING BONNET SEAL

The seal between the body and the bonnet is an O-ring allowing for easier maintenance. And since O-rings seal better than flat gaskets, the number of bonnet bolts is reduced.

STEM PACKING SEALS

M&H utilizes Buna-N multiple V-ring stem packing seals. This sealing system conforms to AWWA C504 and AWWA C507 standards. Replaceable packing seal is held in place with an adjustable gland follower to provide many years of reliable service.

BOLTED BONNET

Valve bonnets are fully sealed and securely bolted to the valve body for easy removal of the plug should maintenance be required.

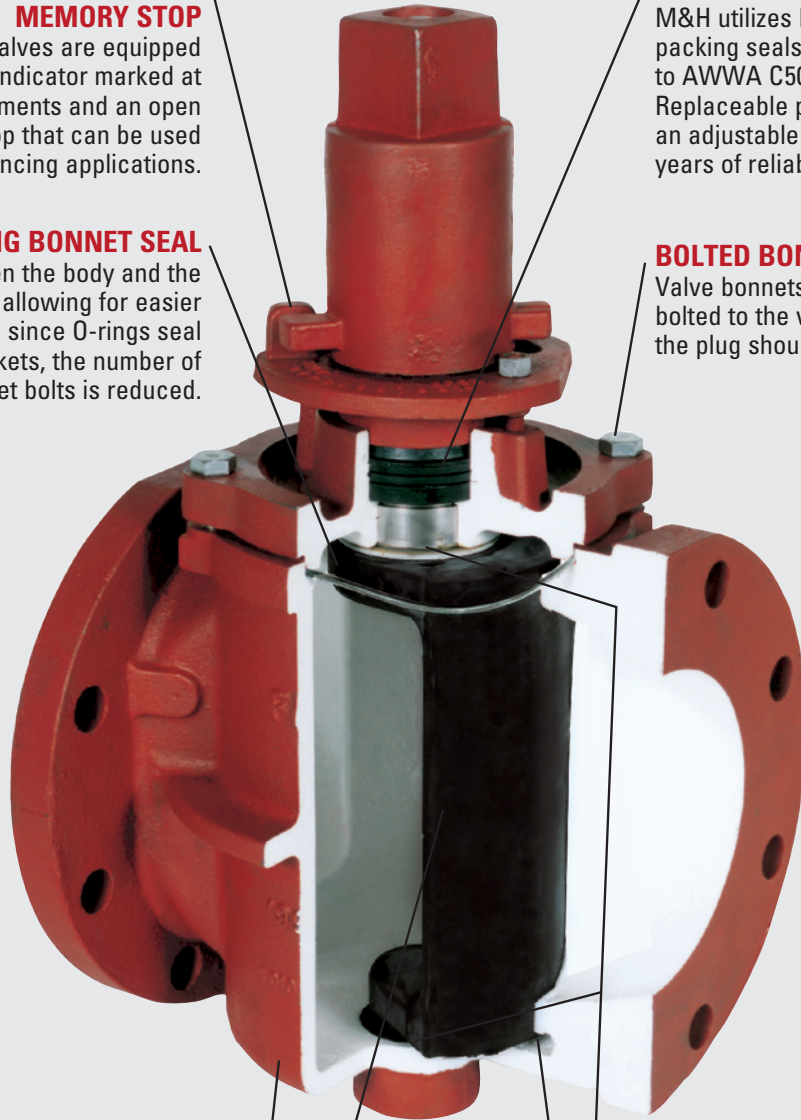

VALVE BODY

The body and cover of the M&H valve are cast iron conforming to ASTM A126 Class B. Flanged valves are in full compliance with ANSI B16.1 Class 125 standards. Mechanical Joint valves are in compliance with AWWA C111/ANSI 211.11, Grooved end valves are in compliance with AWWA C606.

PLUG

The valve plug is cast iron ASTM A126, Class B. The portion of the plug in the valve body cavity is coated with Buna-N rubber using an injection molding process. This allows for the entire surface to be covered, not just the plug face. With this injection molding process you do not have to worry about the rubber disbonding from the iron.

SHAFT BEARINGS

Sintered 316 stainless steel shaft bearings are used in the upper and lower trunnions. These bearings are permanently lubricated for ease of operation even after long periods of inactivity.

WELDED NICKEL SEAT

A corrosion resistant nickel seat is welded to a raised area in the body. The weld is of 95% nickel, at least 1/8" thick after it is machined. The nickel covers the entire seat surface so that there is no possibility of corrosion that could damage the plug face.

RECOMMENDED SPECIFICATIONS

Eccentric Plug Valves shall be of the tight-closing, resilient-faced, non-lubricating variety and shall be of eccentric design such that the valve's pressure member (plug) rises off the body seat contact area immediately upon shaft rotation during the opening movement. Valves shall be bubble-tight at the rated pressure (175 PSI through 12", 150 PSI 14" and above) and shall be satisfactory for applications involving throttling service as well as frequent or infrequent on-off service. The valve closing member should rotate approximately 90 degrees from the full-open to full-closed position.

The valve body shall be constructed of cast iron conforming to ASTM A126, Class B. Body ends shall be:

- 1) Flanged with dimensions, facing, and drilling in full conformance with ANSI B16.1, Class 125.
- 2) Mechanical Joint to meet the requirements of AWWA C111/ANSI A21.11.
- 3) Grooved ends to meet the requirements of AWWA C606.

Eccentric Plug Valves shall have a rectangular shaped port. Port areas for 3" – 20" valves shall be a minimum 80% of full pipe area. Port area for 24" valve shall be a minimum 70% of full pipe area.*

Valve seat surface shall be welded-in overlay, cylindrically shaped of not less than 95% pure nickel. Seat area shall be raised, with raised area completely covered with weld to ensure proper seat contact. The machined seat area shall be a minimum of .125" thick and .500" wide.

The valve plug shall be constructed of cast iron conforming to ASTM A126, Class B. The plug

shall have a cylindrical seating surface that is offset from the center of the plug shafts. The plug shafts shall be integral. The entire plug shall be 100% encapsulated with Buna-N rubber in all valve sizes. The rubber compound shall be approximately 70 (Shore A) durometer hardness. The rubber to metal bond must withstand 75 lbs. pull under test procedure ASTM D429-73 Method B.

Shaft bearings, upper and lower, shall be sleeve-type metal bearings, sintered, oil impregnated and permanently lubricated Type 316 stainless steel conforming to ASTM A743 Grade CF-8M. Thrust bearings shall be Nylatron.

Plug valve shaft seals shall be of the multiple V-ring type (Chevron) and shall be adjustable. All packing shall be replaceable without moving the bonnet or actuator and while the valve is in service. Shaft seals shall be made of Buna-N.

Each valve shall be given a test against the seat at the full-rated working pressure and a hydrostatic shell test at 1.5 times the rated working pressure. Certified copies of individual tests shall be submitted when requested. Certified copies of proof-of-design tests shall be submitted upon request.

Manual valves shall have lever or worm gear type actuators with handwheels, 2" square nuts, or chainwheels attached. Lever actuators shall be furnished on valves 8" and smaller where the maximum unseating pressure is 25 PSIG or less. Worm gear type actuators shall be furnished on all 4" or larger valves where the maximum unseating pressure is 25 PSIG or more.

All eccentric plug valves shall be M&H 1820-02 (flanged), 1820-01 (mechanical joint), or 1820-GR (grooved) or approved equal.

Valves 4" – 8" are available with lever actuators. Geared actuators are recommended on 6" and larger valves. It is also recommended that valves installed in pipelines with high velocity or where water hammer conditions can be caused by sudden valve shut-off be installed with geared actuators. Lever actuators can only be used for pressure ratings of 100 PSI maximum and 25 PSI in the reverse flow condition.

*Note: Full port models shall be a minimum 100% of full pipe area.

ACCESSORIES



FLOOR STANDS

F-5500 STANDARD PATTERN N.R.S.
F-5505 STANDARD PATTERN N.R.S. INDICATING



FLOOR BOX

F-5695 BUSHED
MAX. LENGTH 12"
MAX. STEM DIA. 1 3/4"



STEM GUIDES

F-5660

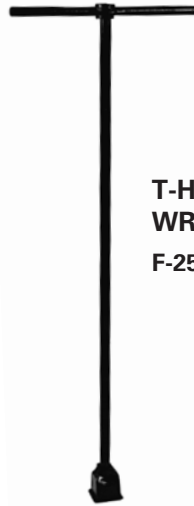

T-HANDLE VALVE WRENCHES

F-2520 RIGID WRENCH



EXTENSION STEMS

DIAMETERS UP TO 2 1/2"
ANY LENGTH

SIZE **MIN. LENGTH** **MAX. LENGTH**

#3	2 1/2"	17"
#5	15"	24"
#6	24"	35"



COMMITTED TO ENVIRONMENTAL RESPONSIBILITY

M&H VALVE COMPANY IS COMMITTED TO PROTECTING OUR NATURAL RESOURCES THROUGH ENVIRONMENTALLY RESPONSIBLE MANUFACTURING PRACTICES, INCLUDING THE USE OF 80+% RECYCLED CONTENT IN OUR HYDRANTS AND VALVES.

To learn more about our commitment to the environment, call 256-237-3521.



www.mh-valve.com



M&H VALVE COMPANY

605 West 23rd Street • Anniston, Alabama 36201
PHONE 256-237-3521 FAX 256-741-6253



For Generations