

OPEN

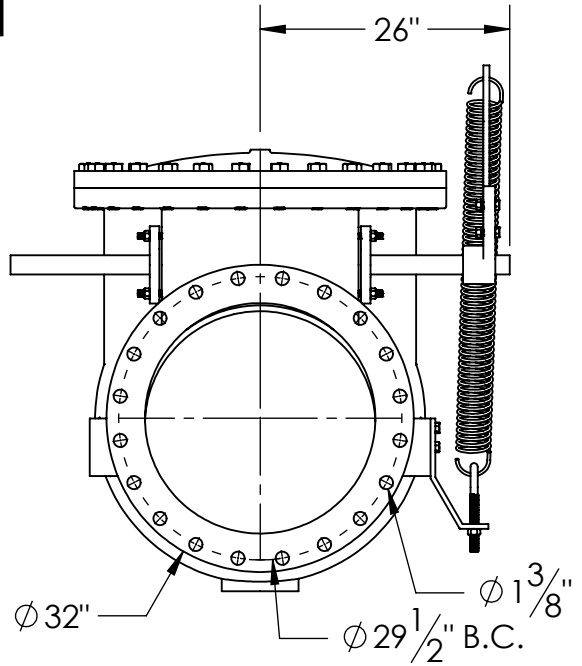

CLOSED

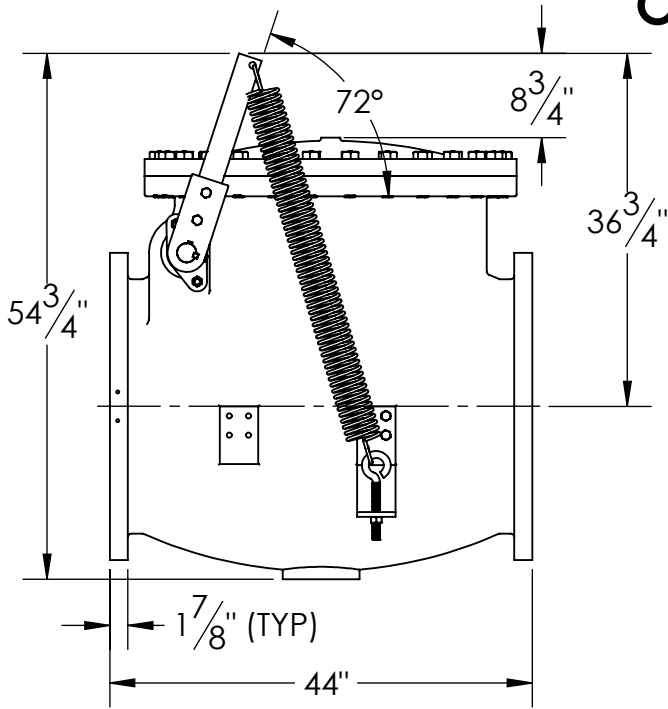
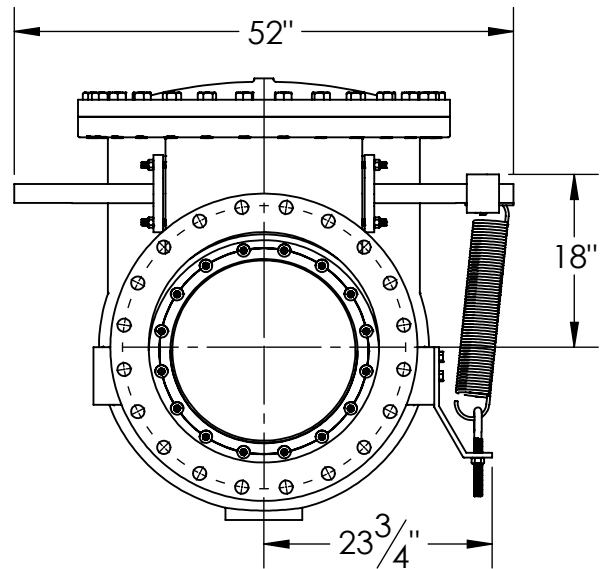
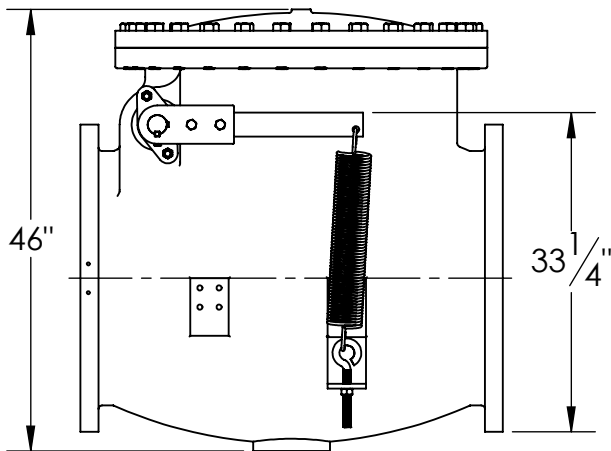

1. FLOW DIRECTION IS SPECIFIED ON VALVE.
2. VALVE WILL MEET OR EXCEED AWWA C508 REQUIREMENTS.
3. RATED AND TESTED FOR 150psi WORKING PRESSURE.
4. VALVES ARE SUITABLE FOR HORIZONTAL OR VERTICAL POSITION INSTALLATION.
5. REFERENCE AWWA C508 FOR FLANGES AND DRILLING.
6. (20) 1 1/2" BOLTS ON EACH FLANGE (NO THREADED HOLES)

THIS DWG. AND ALL INFORMATION IS OUR PROPERTY AND SHALL NOT BE USED, COPIED, OR REPRODUCED WITHOUT WRITTEN CONSENT. DESIGN AND INVENTION RIGHTS RESERVED.



M&H VALVE COMPANY

A DIVISION OF McWANE INC.
P.O. BOX 2088
ANNISTON, ALABAMA 36202

DWG. NO.
CD24-X1111-0010-N00
DRAWN: EMW
DATE: 03/18/2021

REV.
-

24" SPECIAL CHECK VALVE - FLANGED ENDS - LEVER & SPRING DIMENSIONS

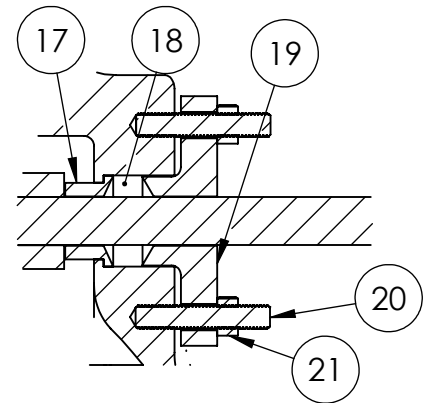
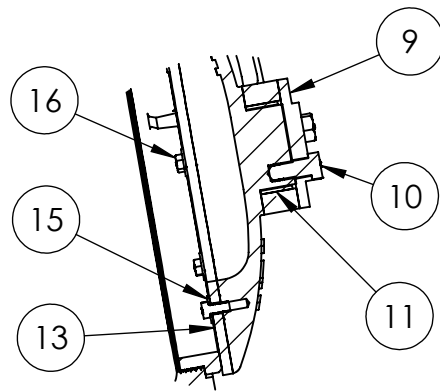
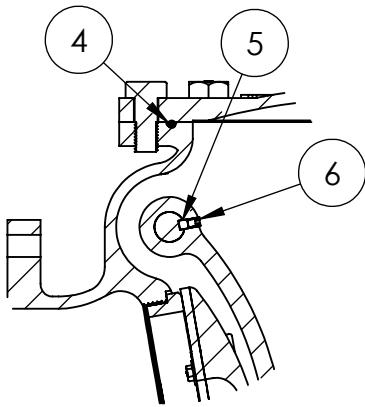
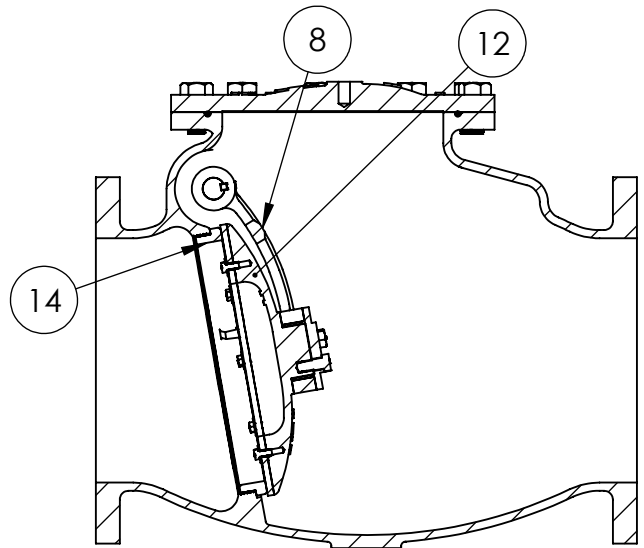
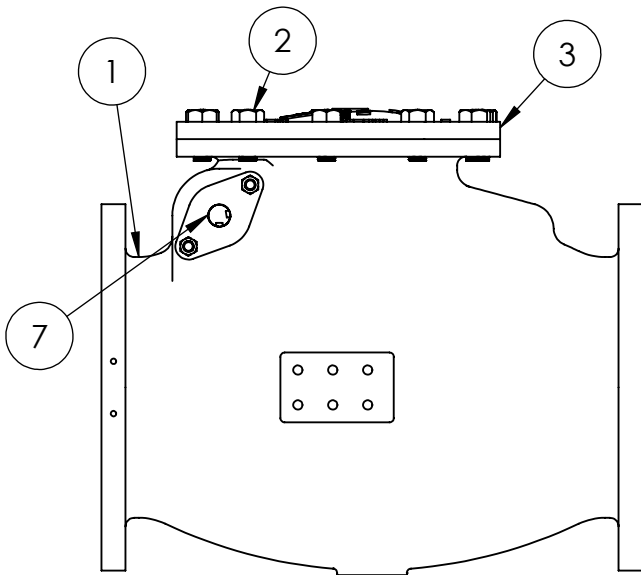

CLAPPER ARM DETAILS

CLAPPER DETAILS

STUFFING BOX DETAILS

ITEM NO.	DESCRIPTION	MATERIAL
1	BODY - F.E.	CAST IRON ASTM A126 CL. B
2	COVER BOLTS	ASTM A-307 GR. B, OR A EZ PLATED
3	COVER	CAST IRON ASTM A126 CL. B
4	COVER O-RING	BUNA "N" DUROMETER 70 APPROVED
5	CLAPPER ARM KEY	304 STAINLESS STEEL
6	SET SCREW	ALLOY STEEL (RC 45-63)
7	HINGE PIN	STAINLESS STEEL ASTM A-276 TYPE 303
8	CLAPPER ARM	DUCTILE IRON A536 65-45-12 OR 70-50-05
9	CLAPPER CAP PLATE	304 STAINLESS STEEL
10	HEX BOLT CAP PLATE	18-8 STAINLESS STEEL
11	CLAPPER ARM BUSHING	BRASS C26000
12	CLAPPER	DUCTILE IRON A536 65-45-12 OR 70-50-05
13	ENCAPSULATED RUBBER CLAMP RING	BUNA "N" DUROMETER 70 APPROVED
14	BODY RING	BRONZE ALLOY C89836
15	WASHER, FLAT	18-8 STAINLESS STEEL
16	HEX BOLT CLAMP RING	18-8 STAINLESS STEEL
17	STUFFING BOX BUSHING	BRONZE ALLOY C87850
18	PACKING	MULTI-LOK BRAID STYLE ML2254 PTFE
19	STUFFING BOX GLAND	DUCTILE IRON A536 65-45-12 OR 70-50-05
20	STUD	STEEL ASTM A307, EZ PLATED
21	HEX NUT	18-8 STAINLESS STEEL

THIS DWG. AND ALL INFORMATION IS OUR PROPERTY AND SHALL NOT BE USED, COPIED, OR REPRODUCED WITHOUT WRITTEN CONSENT. DESIGN AND INVENTION RIGHTS RESERVED.



M&H VALVE COMPANY
 A DIVISION OF McWANE INC.
 P.O. BOX 2088
 ANNISTON, ALABAMA 36202

DWG. NO.
 CBAA-X1111-0000-N00
 DRAWN: EMW
 DATE: 10/5/2021
 REV. -

14" THRU 30" AWWA C508
 SPECIAL CHECK VALVES
 FLANGED ENDS - NSF61/372
 MATERIAL LIST

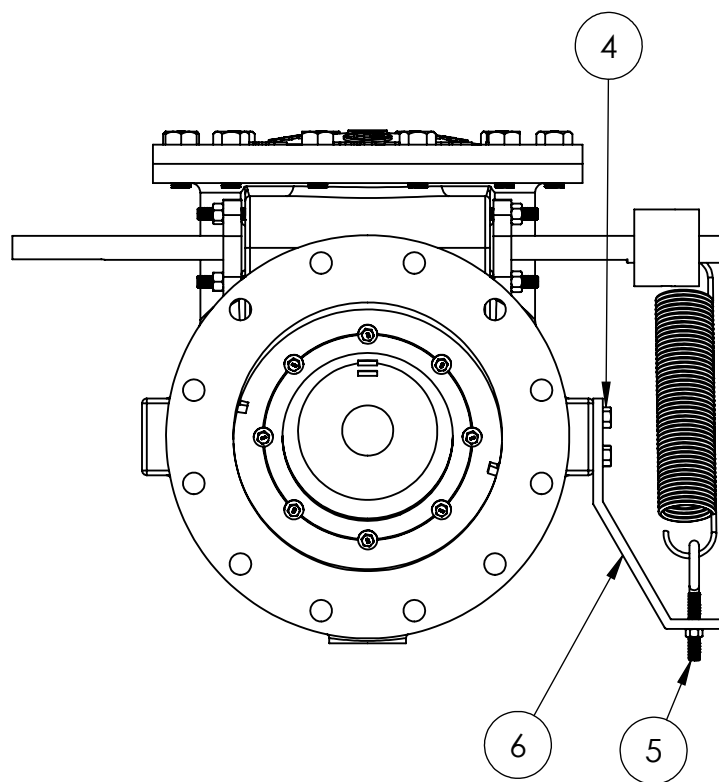
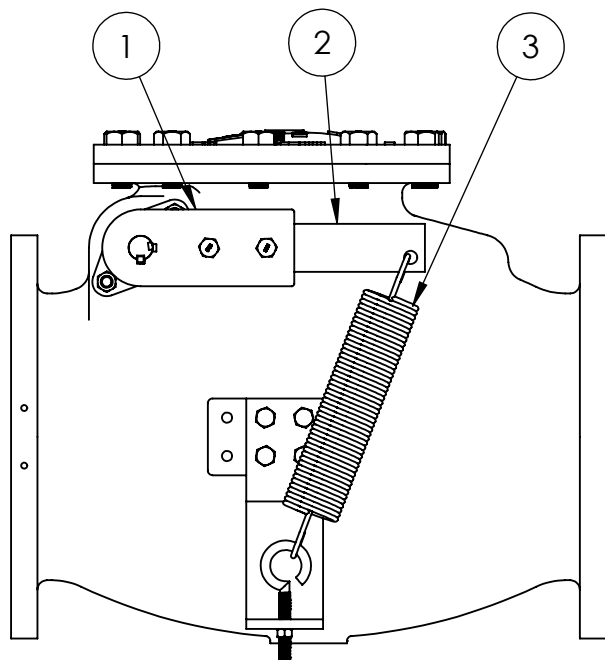

LEVER & SPRING CHECK VALVE ASSEMBLY

ITEM NO.	DESCRIPTION	MATERIAL
1	SPRING ARM LEVER	DUCTILE IRON A536 65-45-12 OR 70-50-05
2	SPRING ARM BAR	CR STEEL C-1018/1020
3	SPRING	STEEL
4	SPRING BRACKET CAP SCREW	STEEL A-307 GRADE B
5	SPRING EYEBOLT	STEEL A-307 GRADE B
6	SPRING BRACKET	STEEL

THIS DWG. AND ALL INFORMATION IS OUR PROPERTY AND SHALL NOT BE USED, COPIED, OR REPRODUCED WITHOUT WRITTEN CONSENT. DESIGN AND INVENTION RIGHTS RESERVED.



M&H VALVE COMPANY
 A DIVISION OF McWANE INC.
 P.O. BOX 2088
 ANNISTON, ALABAMA 36202

DWG. NO.
 CBBB-S1111-0010-N00
 DRAWN: EMW
 DATE: 02/05/2021

REV.
 -

14" THRU 24" LEVER AND SPRING
 AWWA C508 CHECK VALVES
 NSF61/372 - MATERIAL LIST

OPTIONAL BY SPECIAL REQUEST

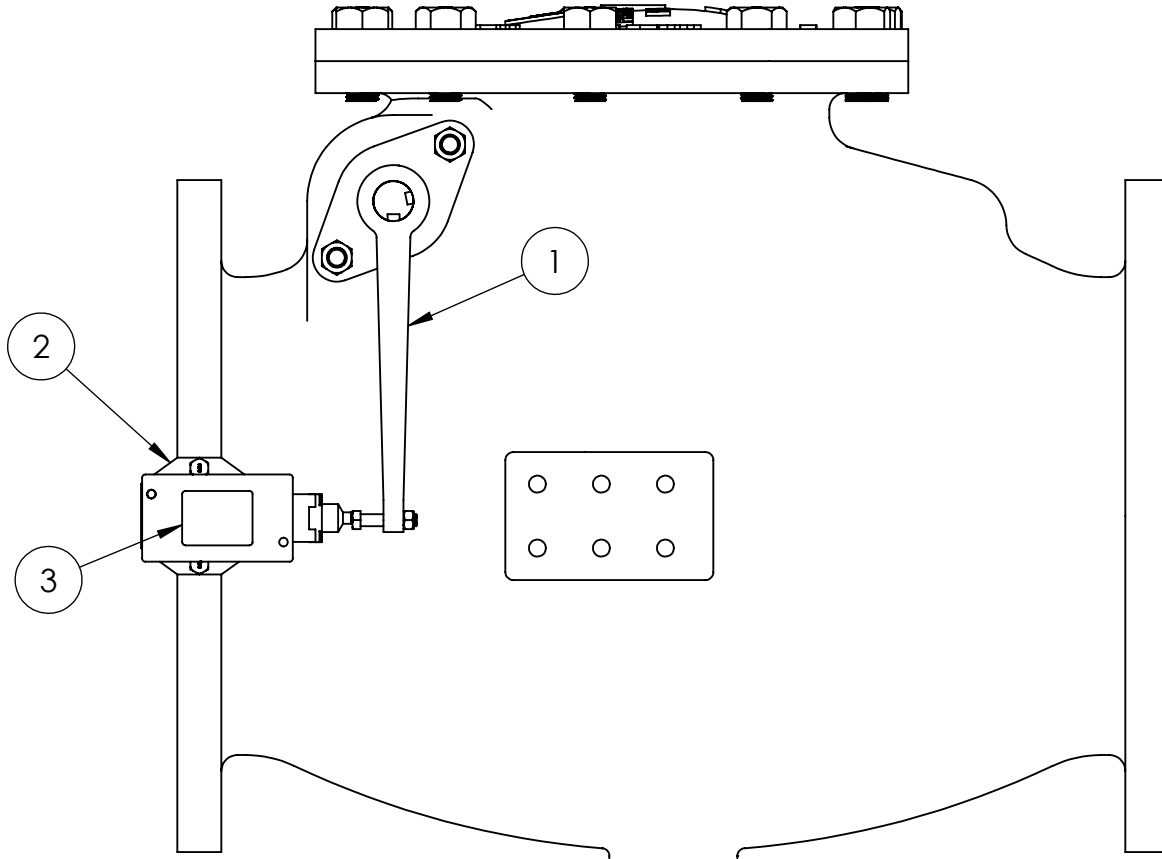

LIMIT SWITCH CHECK VALVE ASSEMBLY

ITEM NO.	DESCRIPTION	MATERIAL
1	TRIPPER ARM	STEEL
2	MOUNTING BRACKET	STEEL
3	LIMIT SWITCH	SD-D-TYPE-CR53E

THIS DWG. AND ALL INFORMATION IS OUR PROPERTY AND SHALL NOT BE USED, COPIED, OR REPRODUCED WITHOUT WRITTEN CONSENT. DESIGN AND INVENTION RIGHTS RESERVED.



M&H VALVE COMPANY

A DIVISION OF McWANE INC.
P.O. BOX 2088
ANNISTON, ALABAMA 36202

DWG. NO.
CBAA-S1111-0000-Y00

DRAWN: EMW	REV.
DATE: 02/22/2021	-

14" THRU 36" LIMIT SWITCH OPTION -
AWWA C508 CHECK VALVES
NSF61/372 - MATERIAL LIST